



© GIA. Photo by Robert Weldon.

Species - Variety:

Zircon

Locality (as stated in Dr. Gübelin's records):

Thailand

Description

Shape: Round
Weight: 11.48 ct
Dimensions: 12.93 x 13.14 x 7.84 mm
Diaphaneity: Transparent
Color: Light, very slightly brownish, yellowish Orange

Gemological Properties

Optical Character: Uniaxial positive
Refractive Index: Over the limit
Birefringence: Not calculated
Specific Gravity: 4.70
Pleochroism: None
Luster: Vitreous
Phenomenon: None
Fluorescence:
 LWUV: Weak orangy yellow with even distribution
 SWUV: Weak greenish blue with uneven distribution
Phosphorescence:
 LWUV: None
 SWUV: None
Absorption Spectrum:
 Broad absorption above 670 nm; lines at 485, 518, 539, 562, 589, 615, 653, and 657 nm

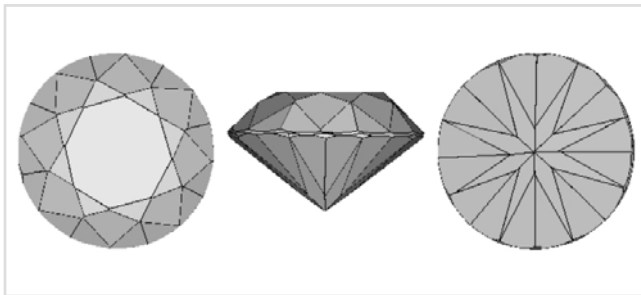

Facet Diagram: top | side | bottom

Photomicrograph

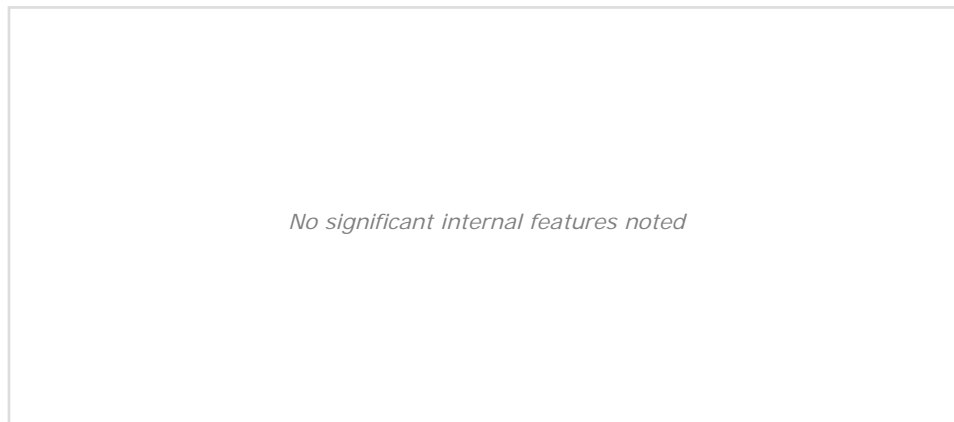

No significant internal features noted



© GIA. Photo by Robert Weldon.

Spectrum

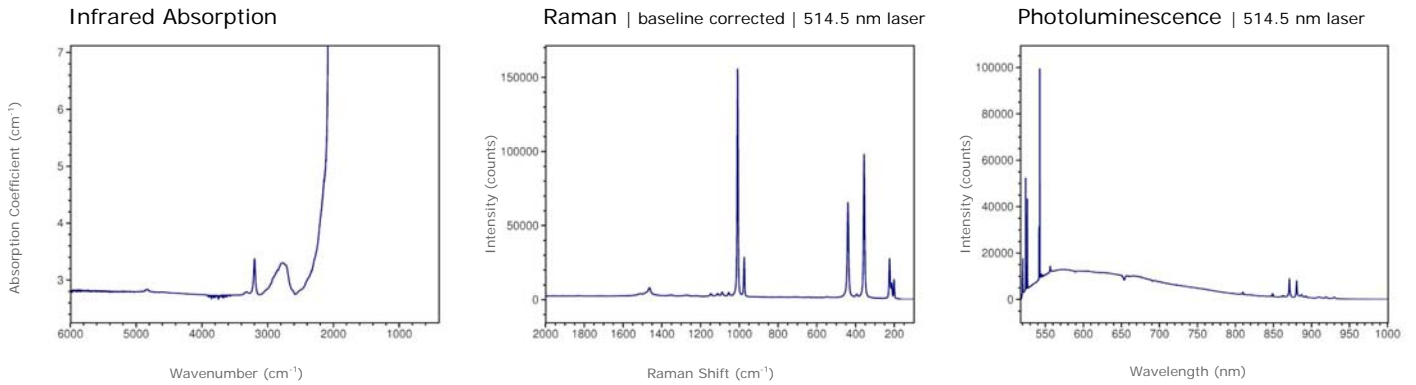

Transmission infrared absorption spectra were collected in the mid-IR range ($400\text{--}6000\text{ cm}^{-1}$) using a Thermo-Nicolet 6700 FTIR spectrometer (KBr beamsplitter, MCT-B detector, 1 to 4 cm^{-1} resolution, and 128 scans). A 6x beam condenser was used to focus light through the girdle region of the gemstone to obtain a maximum signal.

Raman spectra were collected over the range $100\text{--}2000\text{ cm}^{-1}$ Raman shift using a Renishaw InVia Raman microscope (3 additive scans, and excitation produced by 514.5 nm Ar-ion or 633 nm He-Ne lasers). Analysis was done using a focused beam on the table facet of the gemstone unless otherwise noted.

Photoluminescence spectra were collected in the 517–1000 nm range using a Renishaw InVia Raman microscope (single scan, and excitation produced by 514.5 nm Ar-ion laser). Analysis was done using a focused beam on the table facet of the gemstone unless otherwise noted, and the laser intensity was adjusted to avoid detector saturation caused by sample fluorescence.

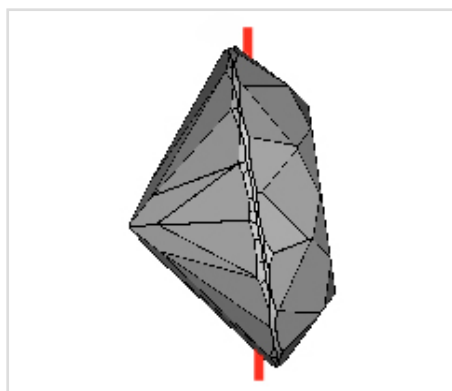

Red line denotes the approximate position of the optic axis

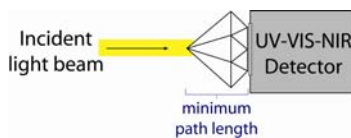

Visible Absorption | min. path length: 7.8 mm

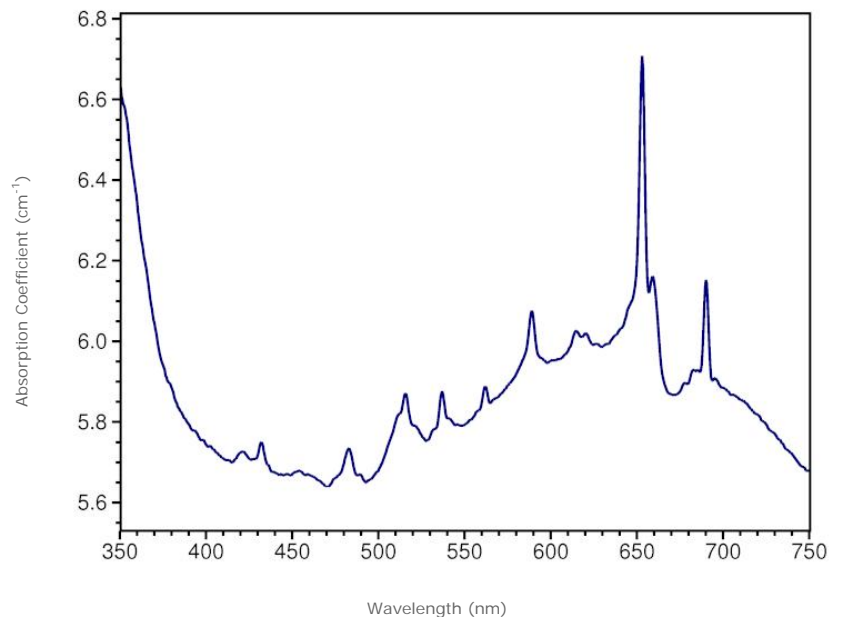

Transmission absorption spectra in the UV to near-IR range ($250\text{--}1000\text{ nm}$) were collected using a Hitachi U4001 spectrometer (2.0 nm slit, 1.0 nm data interval, and 120 nm/min scan speed). Unless otherwise noted, an unpolarized light beam was focused on the culet area of the optically unoriented sample.



© GIA. Photo by Robert Weldon.

Chemistry | EDXRF

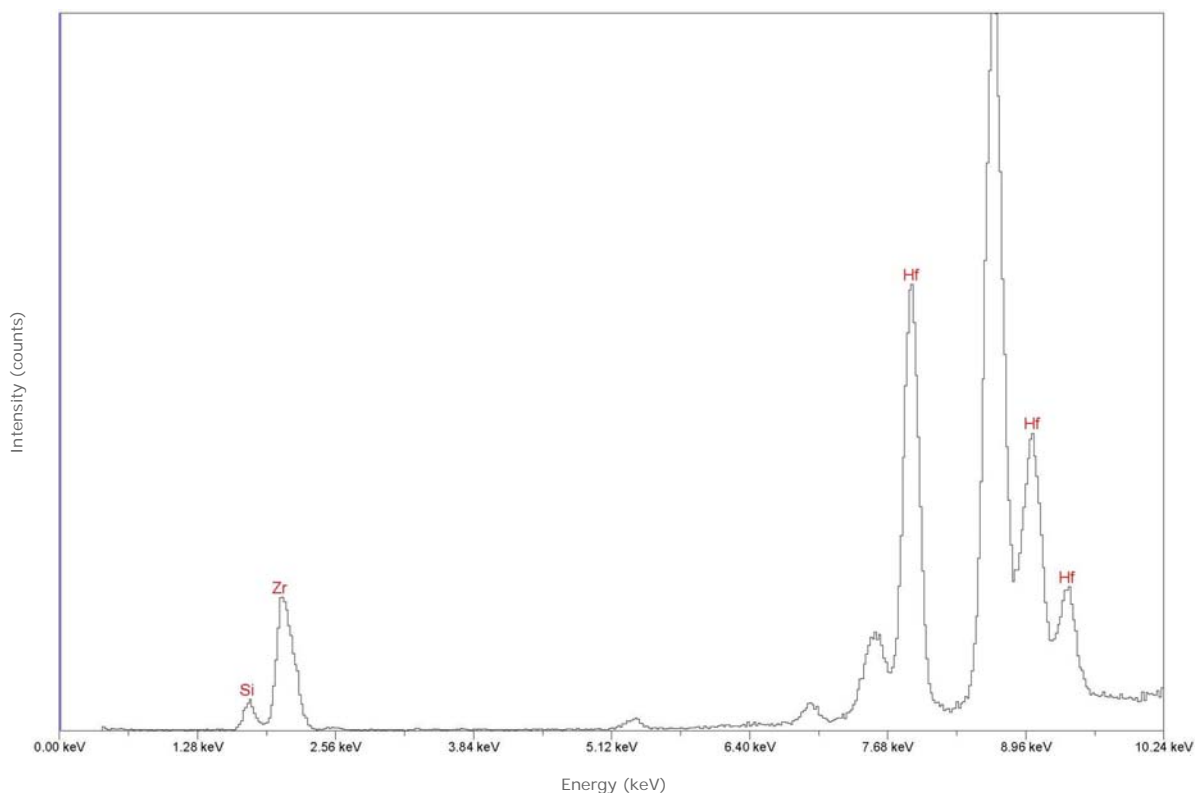

Qualitative energy-dispersive X-ray fluorescence (EDXRF) data were collected using a Thermo ARL QuantX EDXRF analyzer (15 kV, 0.02–1.98 mA (auto adjusted based on deadtime), 100 seconds livetime, vacuum atmosphere, aluminum filter). These conditions were selected to optimize the detection of the transition metals (such as iron or chromium) that are responsible for the coloration of most gemstones. Only the peaks for chemical elements that were clearly identifiable are labeled by element symbols in the spectrum. Most other peaks are diffraction artifacts. Our EDXRF method can detect most elements with higher atomic numbers than sodium (Z=11) in the Periodic Table; depending on the element, the lower limit of detection is between 1 and 100 parts per million (0.0001 to 0.01%).