



© GIA. Photo by Robert Weldon.

Species - Variety:

Beryl - Emerald

Locality (as stated in Dr. Gübelin's records):

Russia, Ural Mountains Region

Description

Shape: Square Emerald

Weight: 1.13 ct

Dimensions: 6.70 x 6.16 x 3.42 mm

Diaphaneity: Transparent

Color: Light, very slightly grayish, Green

Gemological Properties

Optical Character: Uniaxial negative

Refractive Index: 1.588 / 1.595

Birefringence: 0.007

Specific Gravity: 2.80

Pleochroism: Light green / Light blue-green

Luster: Vitreous

Phenomenon: None

Fluorescence:

LWUV: None

SWUV: None

Phosphorescence:

LWUV: None

SWUV: None

Absorption Spectrum:

Broad absorption below 440 nm; lines at about 635, 656 and 682 (doublet) nm

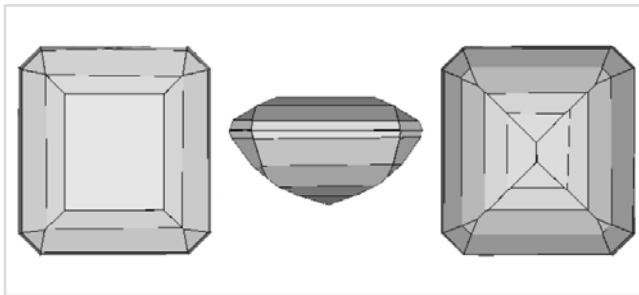

Facet Diagram: top | side | bottom

Photomicrograph

This emerald contains partially healed fractures, fluid inclusions, and several solid inclusions many of which are colorless fibers.

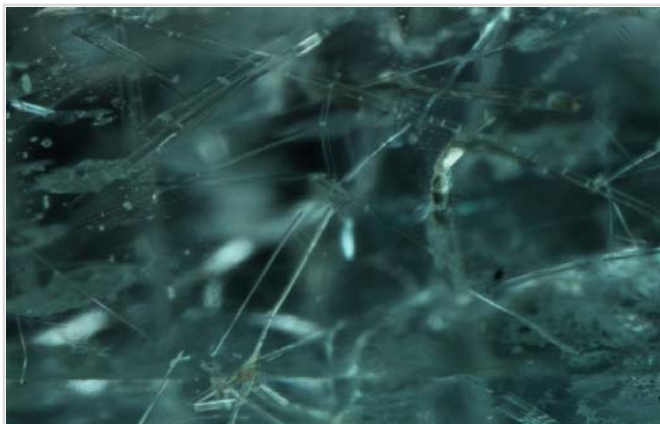

A group of colorless fiber inclusions that are believed to be an amphibole mineral. The field of view is 1.75 mm across.

Magnification: 50x

© GIA. Photomicrograph by John Koivula.

GIA Gem Database | Edward J. Gübelin Collection

Beryl - Emerald | Russia, Ural Mountains Region
GIA Collection Number: 33876



© GIA. Photo by Robert Weldon.

Spectrum

Infrared Absorption

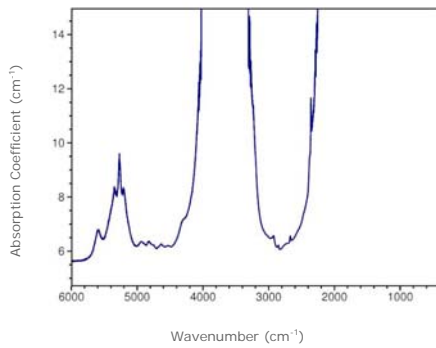

Raman | baseline corrected | 514.5 nm laser

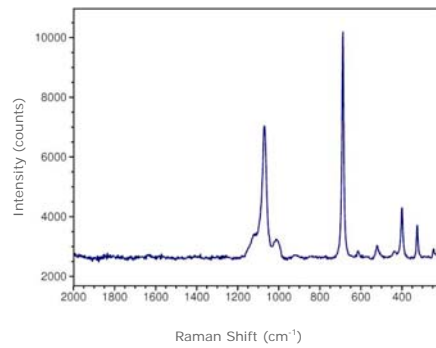

Photoluminescence | 514.5 nm laser

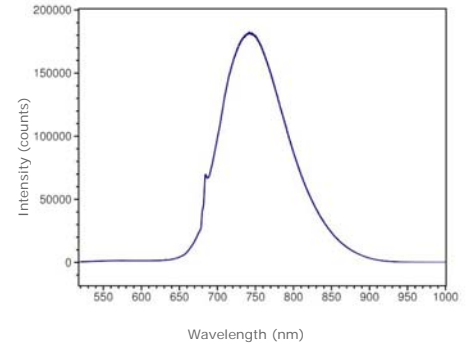

Transmission infrared absorption spectra were collected in the mid-IR range (400–6000 cm^{-1}) using a Thermo-Nicolet 6700 FTIR spectrometer (KBr beamsplitter, MCT-B detector, 1 to 4 cm^{-1} resolution, and 128 scans). A 6x beam condenser was used to focus light through the girdle region of the gemstone to obtain a maximum signal.

Raman spectra were collected over the range 100–2000 cm^{-1} Raman shift using a Renishaw InVia Raman microscope (3 additive scans, and excitation produced by 514.5 nm Ar-ion or 633 nm He-Ne lasers). Analysis was done using a focused beam on the table facet of the gemstone unless otherwise noted.

Photoluminescence spectra were collected in the 517–1000 nm range using a Renishaw InVia Raman microscope (single scan, and excitation produced by 514.5 nm Ar-ion laser). Analysis was done using a focused beam on the table facet of the gemstone unless otherwise noted, and the laser intensity was adjusted to avoid detector saturation caused by sample fluorescence.

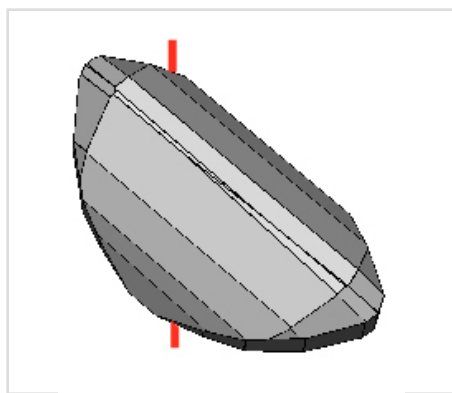

Red line denotes the approximate position of the optic axis



Visible Absorption | min. path length: 3.4 mm

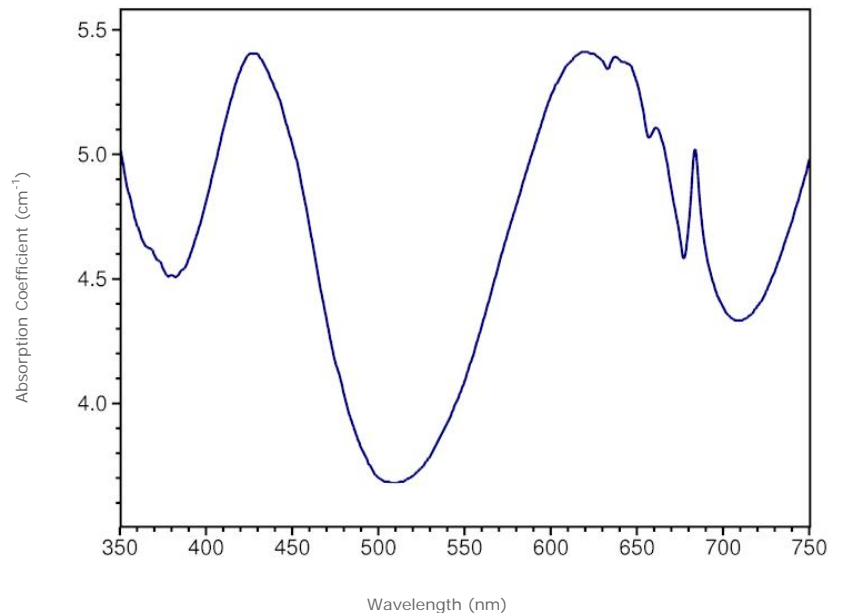

Transmission absorption spectra in the UV to near-IR range (250–1000 nm) were collected using a Hitachi U4001 spectrometer (2.0 nm slit, 1.0 nm data interval, and 120 nm/min scan speed). Unless otherwise noted, an unpolarized light beam was focused on the culet area of the optically unoriented sample.



© GIA. Photo by Robert Weldon.

Chemistry | EDXRF

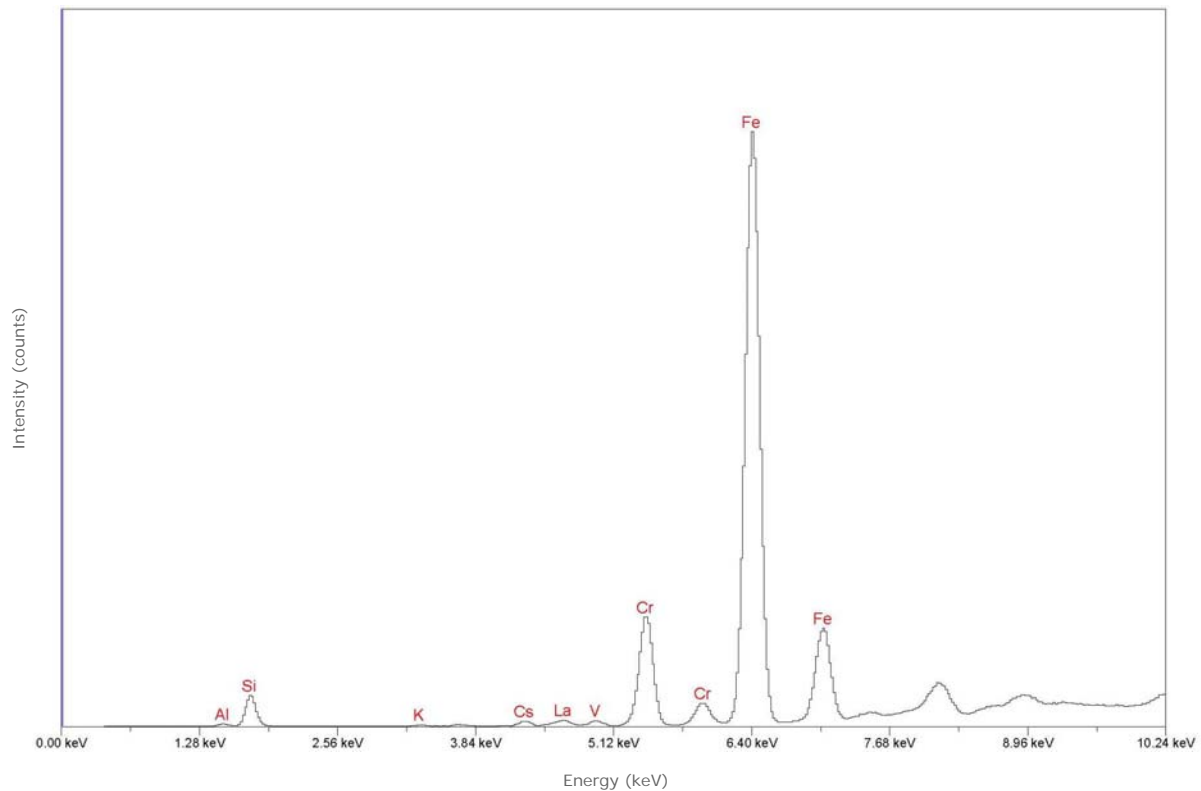

Qualitative energy-dispersive X-ray fluorescence (EDXRF) data were collected using a Thermo ARL QuantX EDXRF analyzer (15 kV, 0.02–1.98 mA (auto adjusted based on deadtime), 100 seconds livetime, vacuum atmosphere, aluminum filter). These conditions were selected to optimize the detection of the transition metals (such as iron or chromium) that are responsible for the coloration of most gemstones. Only the peaks for chemical elements that were clearly identifiable are labeled by element symbols in the spectrum. Most other peaks are diffraction artifacts. Our EDXRF method can detect most elements with higher atomic numbers than sodium (Z=11) in the Periodic Table; depending on the element, the lower limit of detection is between 1 and 100 parts per million (0.0001 to 0.01%).